

Wolffpac Technologies

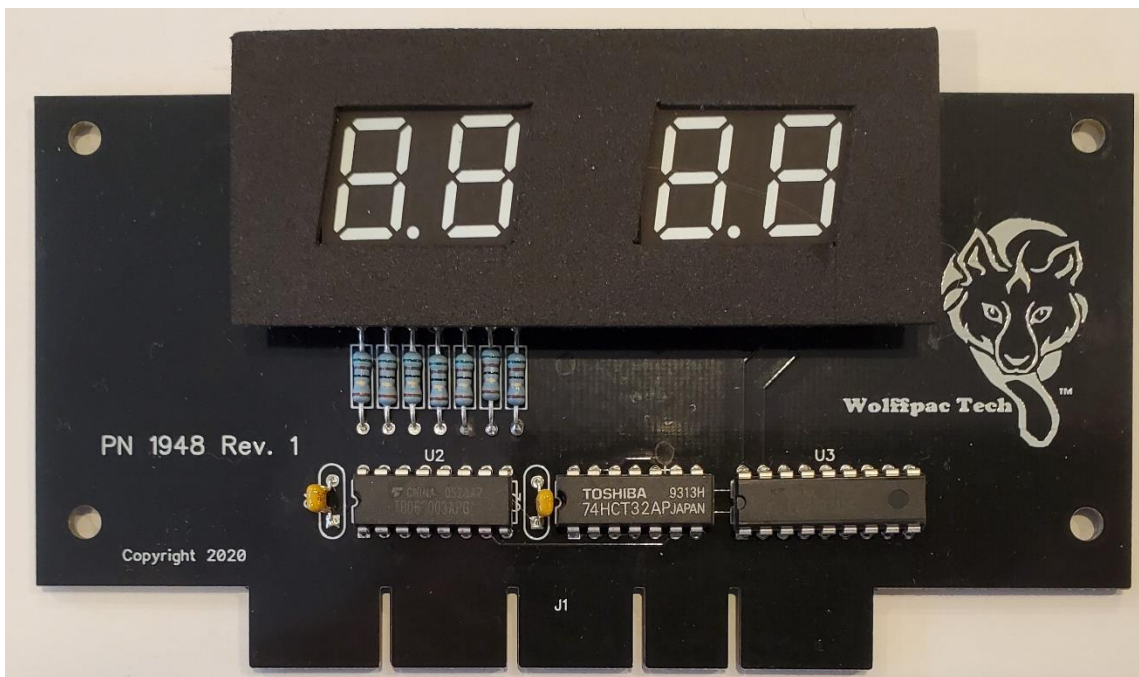

Gottlieb™ 4-Digit Replacement Display Kit



Assembly Instructions

wolffpactech.com

When assembled, this display will replace the displays used on Gottlieb™ System 1 and System 80 solid state pinball machines. For the complete list of compatible machines, see the list at the end of these instructions. Gottlieb™ is a registered trademark of Gottlieb Development LLC.

Tools:

Soldering iron - A small to medium power soldering iron of 25-50 watts with a small tip, preferably temperature controlled, is recommended.

Wire cutters - A set of diagonal or wire cutters intended for cutting electronic component leads.

Alcohol –Isopropyl Alcohol, Denatured Alcohol or Flux Remover to be used for cleaning the board after assembly.

Solder - Use only solder designated for electronic component assembly. Either lead-based or lead-free flux-core solder are both acceptable.

→ Use of solid core, acid core or plumbing solder is not acceptable and will void the warranty. ←

All soldering should be done on the bottom (non-printed) side of the boards. This kit uses “old school” through-hole components requiring only basic soldering skills to assemble. However, if you have never soldered before or are unsure of your skill level, it is recommended that you first practice soldering on a scrap board before beginning to assemble this kit. There are many references on the internet which can help you learn how.

Caution -



Warning







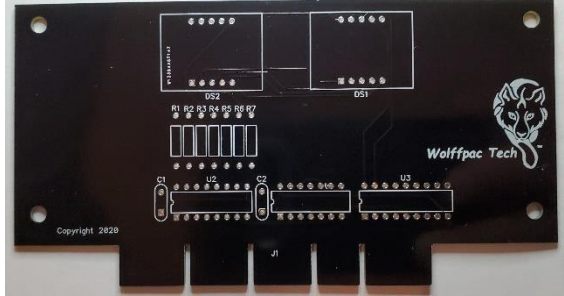

Solder melts at around 400°F to 600°F (200°C to 300°C). Remember to use care when soldering as both the soldering iron and solder are extremely hot and can produce serious burns. Make sure that you use an appropriate work surface since molten solder may drip and hot solder and components may damage or burn many materials.

Eye protection is recommended as solder can splash and component leads may fly when cut.

We are not responsible for any damage or injury as a result of assembling this kit.

Remember: Solder and components will remain very hot for several minutes after soldering.

Parts List:

| Part Description | Ref | Qty | |
|--|-------------|-----|--|
| Printed Circuit Board, Marked: P/N 1948 | | 1 |  |
| IC, Marked: 74HCT32 | U1 | 1 |  |
| IC, Marked: TBD62783 | U3 | 1 |  |
| IC, Marked: TBD62003 | U2 | 1 |  |
| Capacitor 0.1uF, Marked: 104 | C1, C2 | 2 |  |
| Resistor, 51 ohm Marked: Green-Brown-Black-Gold-Brown | R1-R9 | 7 |  |
| 2 Digit LED Display | DS7, DS8 | 2 |  |
| Foam Bezel | | 1 |  |

Start Here:

Before starting, check the components received against the parts list on page two. (We do occasionally make mistakes!) If any components are missing, or you have any questions regarding these assembly instructions please contact Wolffpac Tech at 'wolffpactech@gmail.com'.

If you have any problems with the display after assembly, you may contact Wolffpac Tech at 'wolffpactech@gmail.com'. If you need to return the display for repair, we will provide a pre-paid return label. Any problem found to be due to defective components will be repaired free of charge within 1 year of purchase. Any problem found to be due to assembly error or damage will be charged for postage and the cost of any components which need to be replaced.

Step 1: Start with the PC Board (marked P/N 1948):

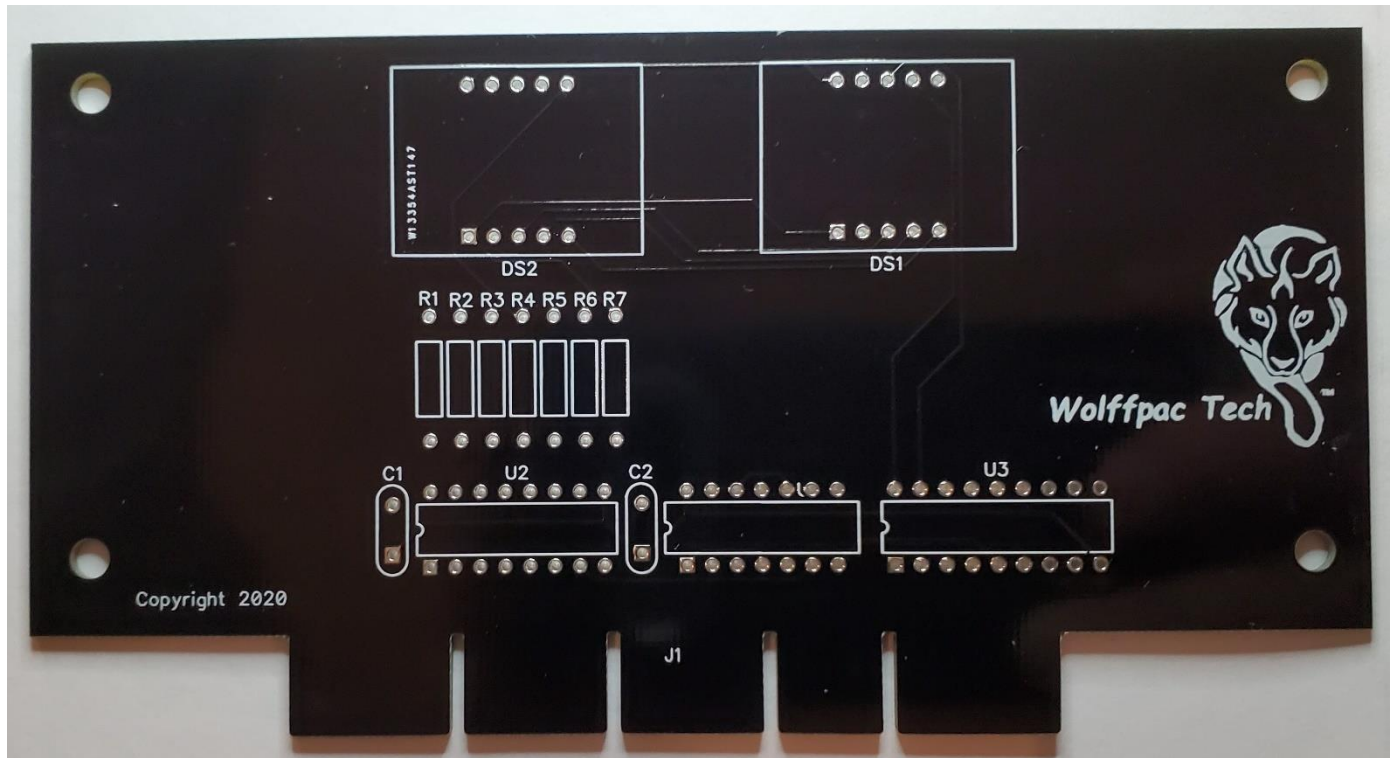

Insert U1 (74HCT32) into the board from the top side (the side with the lettering) so that one pin goes through each hole at the location labeled 'U1'. Each chip is marked with a 'U'-shaped notch on one of the short ends:



This end should line up with the notch printed on the PC board. You may find that you have to bend the legs of the chip slightly in order to get both rows to line up with the holes in the board. You can do this with needle nose pliers or by laying the chip on its side with the pins of one side on a hard surface pointing away from you and gently pressing down and away on the body of the chip. Be careful not to bend the pins too far. Once inserted, bend the pins at the corners from the bottom slightly in order to hold the chip in place.

Make sure that all of the pins from the chip are completely inserted through the holes in the board before soldering in place from the bottom.

Step 2. Repeat for U2 (TBD62003)

Step 3. Repeat for U3 (TBD62783)

Step 4: Locate resistors R1-R7 (51 ohm resistors). Bend the leads of one resistor approximately 90° near the body of the resistor so that it forms a 'U' shape. Do not force the bend any closer than it will go with light finger pressure or you may damage the component. Insert the resistor into the board at the position marked R1 on the board. The

board, bend the leads slightly from the bottom to hold the resistor against the board. Solder from the bottom. Trim the excess leads from the bottom of the board with diagonal cutters leaving about 1/16 inch. Repeat for R2 through R7.

Step 5: Locate capacitors C1, C2 and C5. Insert one capacitor at the positions marked C1 on the board. The direction of these component does not matter. Bend the leads slightly from the bottom of the board to hold in position and solder in place. Trim the excess lead length to about 1/16 inch. Repeat for C2 and C5.

Step 12: 2-Digit LED's. The LED's are installed in positions DS1-DS2.

Important: Install the LEDs so that the side with the decimal point ('.') is facing towards the bottom of the display (the side with the edge connector). Lay the board face down and solder one pin in each row of the LED. Inspect to ensure that the LED is seated flush with the PC board. If not, reheat the pin while pressing on the display from the front of the board. Once the LED is correctly seated, solder the remaining pins. Repeat for the remaining LED display.

Final Assembly

Step 1. Wipe or rinse the boards with Isopropyl Alcohol, Denatured Alcohol, Flux Remover or water depending on the type of solder used to remove the solder flux residue.

Step 2. When the board is completely dry, peel the clear plastic protective film from the front surface of each LED display.

Step 3. Once the displays are dry, remove the paper backing covering the adhesive from the back of the foam bezel. Carefully line the openings with the LEDs and install as shown below.

Note: The adhesive is very aggressive. Be careful when handling the bezel after removing the paper backing to avoid sticking it to something or somewhere you didn't intend!

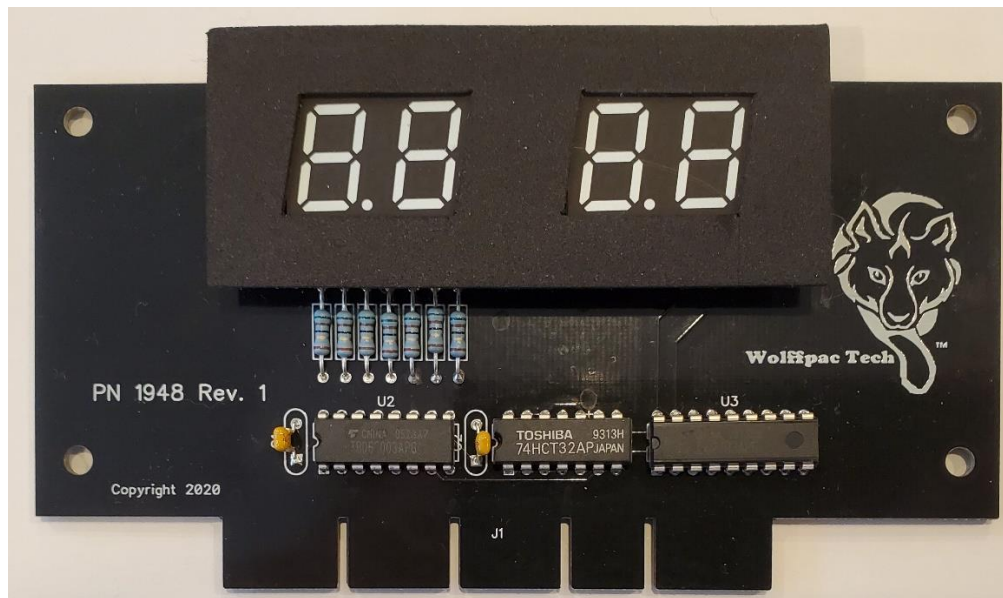

Step 3. install the display in your pinball machine with the power off and attach the original cable. Apply power and enjoy!

Note: These displays can safely be used with the existing displays in your machine.

This is believed to be an accurate list of machines with displays compatible with this replacement. Since we are unable to test this board in every configuration, we take no responsibility for any errors. However, we do welcome feedback as to any errors that are found so that we can update this list.

System 1

Asteroid Annie and the Aliens
Buck Rogers
Charlie's Angels
Cleopatra
Close Encounters of the Third Kind
Count-Down
Dragon
Genie
Joker Poker
Pinball Pool
Roller Disco
Sinbad
Solar Ride
The Incredible Hulk
Torch
Totem

System 80

Black Hole
Circus
Counterforce
Eclipse
Force II
Haunted House
James Bond 007
Mars God of War
Panthera
Pink Panther
Star Race
The Amazing Spider-Man
Time Line
Volcano

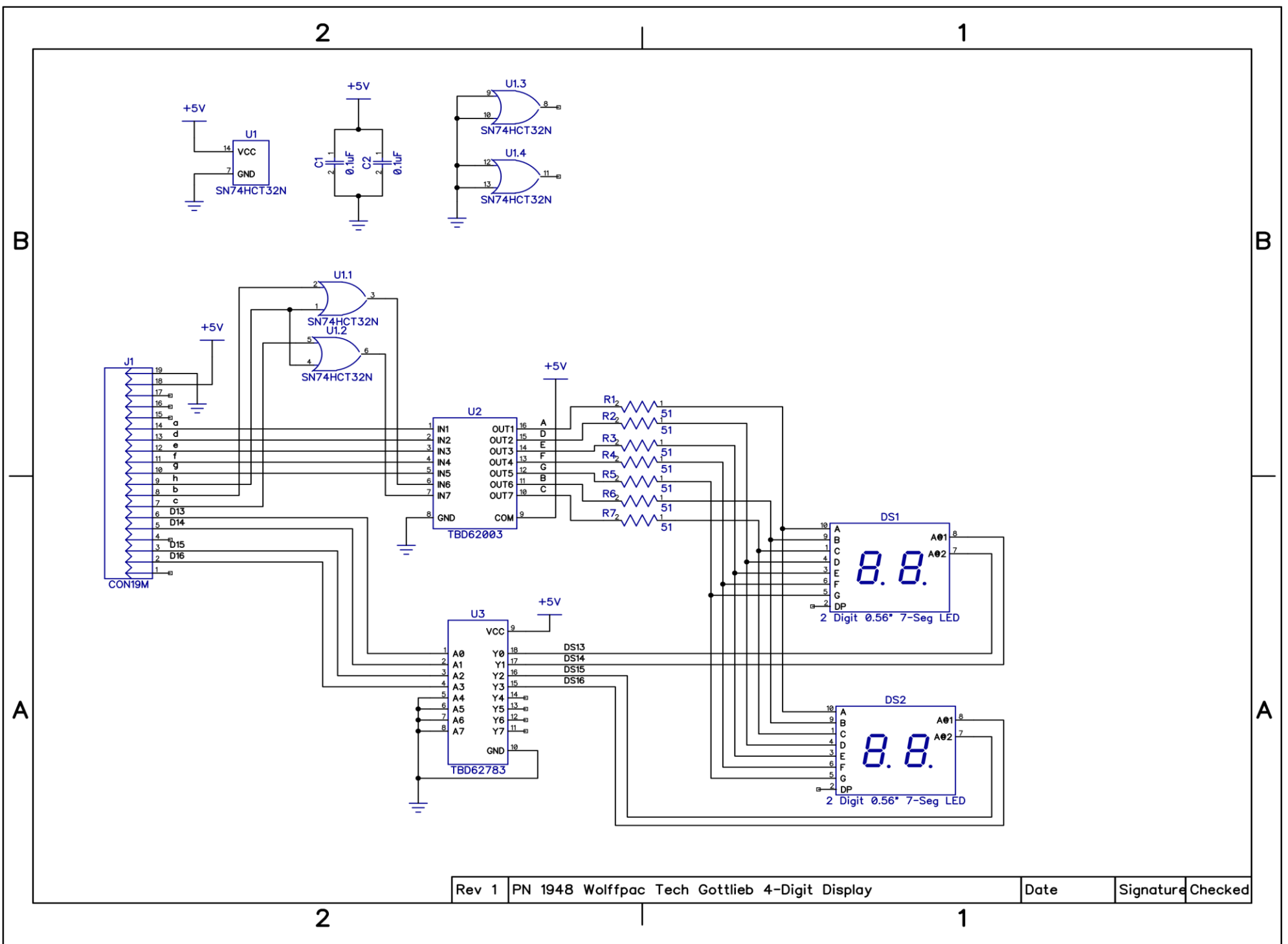

Rev 1 | PN 1948 Wolffpac Tech Gottlieb 4-Digit Display | Date | Signature | Checked