

# Wolffpac Technologies

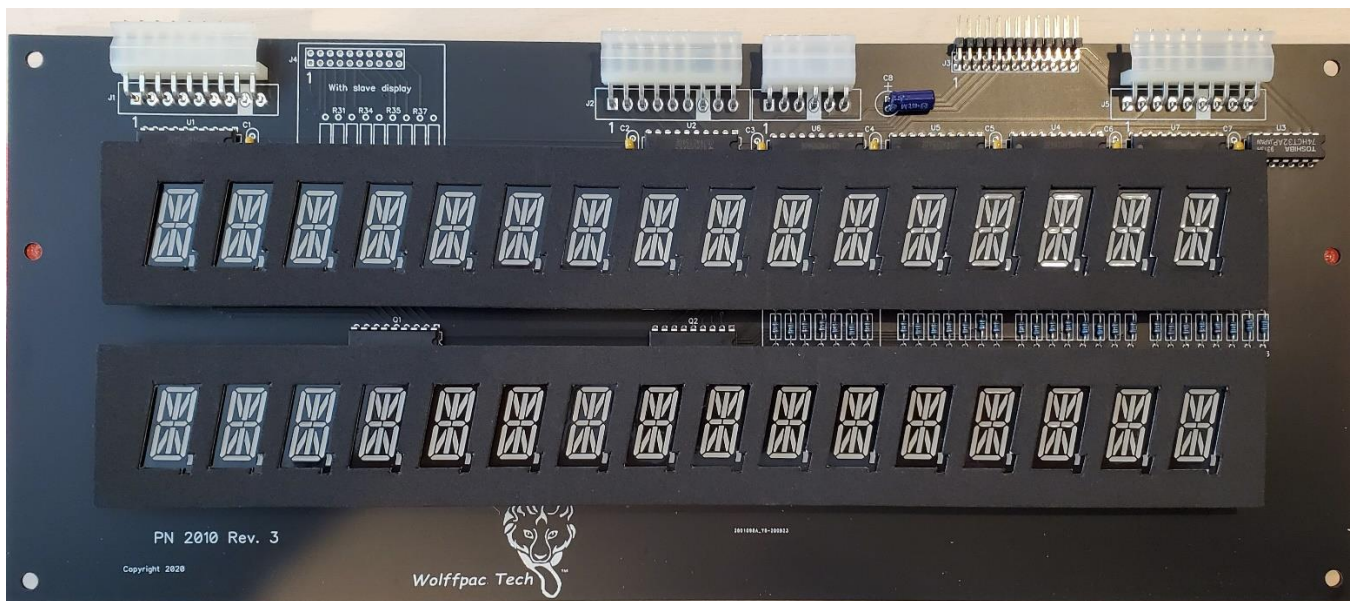

## Williams™ System 11BC/D-12232-1 Replacement Display Kit



## Assembly Instructions

[wolffpactech.com](http://wolffpactech.com)

When assembled, this display will replace the displays used on Williams solid state pinball machines which use the “D-12232-1” display controller. For the complete list of compatible machines, see the list at the end of these instructions.

**Tools:**

Soldering iron - A small to medium power soldering iron of 25-50 watts with a small tip, preferably temperature controlled, is recommended.

Wire cutters - A set of diagonal or wire cutters intended for cutting electronic component leads.

Alcohol –Isopropyl Alcohol, Denatured Alcohol or Flux Remover to be used for cleaning the board after assembly.

Solder - Use only solder designated for electronic component assembly. Either lead-based or lead-free flux-core solder are both acceptable.

**→ Use of solid core, acid core or plumbing solder is not acceptable and will void the warranty. ←**

All soldering should be done on the bottom (non-printed) side of the boards. This kit uses “old school” through-hole components requiring only basic soldering skills to assemble. However, if you have never soldered before or are unsure of your skill level, it is recommended that you first practice soldering on a scrap board before beginning to assemble this kit. There are many references on the internet which can help you learn how.



## **Caution - Warning**





**Solder melts at around 400°F to 600°F (200°C to 300°C). Remember to use care when soldering as both the soldering iron and solder are extremely hot and can produce serious burns. Make sure that you use an appropriate work surface since molten solder may drip and hot solder and components may damage or burn many materials.**

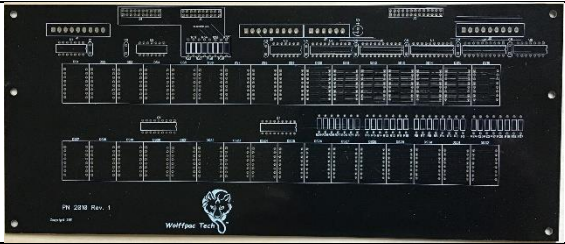

**Eye protection is recommended as solder can splash and component leads may fly when cut.**

**We are not responsible for any damage or injury as a result of assembling this kit.**

**Remember: Solder and components will remain very hot for several minutes after soldering.**

## Parts List:

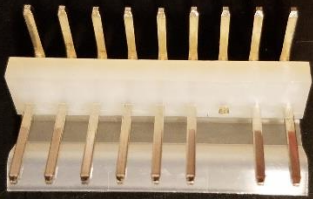
Part Description	Ref	Qty	
Printed Circuit Board 'Master', Marked: P/N 2010		1	
IC, Marked: 74ACT540	U1, U2, U4 - U7	6	
IC, Marked: 74ACT08	U3	1	
IC, Marked: ULN2803 or TBD62083	Q1, Q2	2	
Capacitor 0.1uF, Marked: 104	C1-C7	7	
Capacitor 10uF	C8	1	
14-Segment LED Display	DS	32	
16-digit Foam Bezel		2	
Resistor, See table 1 for value and marking based on the color of the LED digits in your kit:	R1-R39	32	
Connector, 0.156", 1x6	J7	1	
Connector, 0.156", 1x9, A	J1	1	

Connector, 0.156", 1x9, B	J2	1	
Connector, 0.156", 1x9, C	J5	1	
Connector, 0.1", 2x13, Right Angle	J3	1	

<b>Table 1, Resistor value (R1-R39)</b>		
<b>LED display color</b>	<b>Value</b>	<b>Marking</b>
Orange	120 Ohm	Brown-Red-Black-Black-Brown
Red	150 Ohm	Brown-Green-Black-Black-Brown
Blue	100 Ohm	Brown-Black-Black-Black-Brown
Green	150 Ohm	Brown-Green-Black-Black-Brown
White	100 Ohm	Brown-Black-Black-Black-Brown

## Start Here:

Before starting, check the components received against the parts list on page two. (We do occasionally make mistakes!) If any components are missing, or you have any questions regarding these assembly instructions please contact Wolffpac Tech at 'wolffpactech@gmail.com'.

If you have any problems with the display after assembly, you may contact Wolffpac Tech at 'wolffpactech@gmail.com'. If you need to return the display for repair, we will provide a pre-paid return label. Any problem found to be due to defective components will be repaired free of charge within 1 year of purchase. Any problem found to be due to assembly error or damage will be charged for postage and the cost of any components which need to be replaced.

## 'Master' Board:

Step 1: Start with the larger 'Master' PC Board (marked P/N 2010):

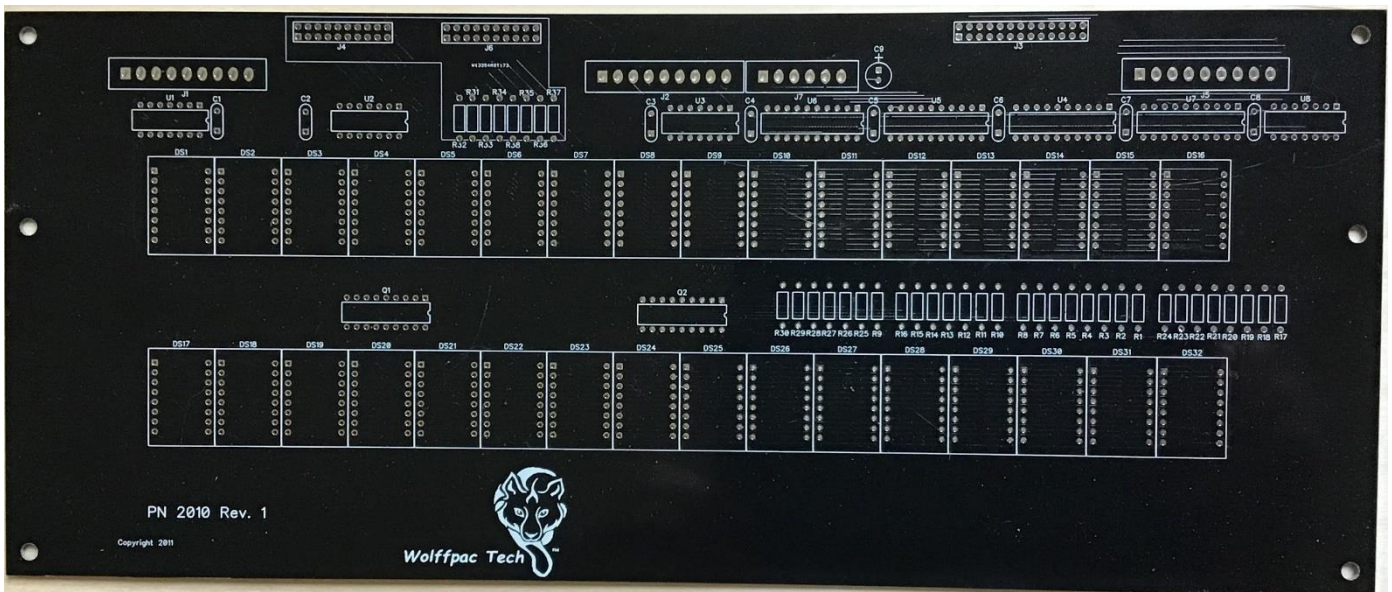

Insert U3 (74ACT08) into the board from the top side (the side with the lettering) so that one pin goes through each hole at the location labeled 'U3'. Each chip is marked with a 'U'-shaped notch (or dot) on one of the short ends:



This end should line up with the notch printed on the PC board. You may find that you have to bend the legs of the chip slightly in order to get both rows to line up with the holes in the board. You can do this with needle nose pliers

or by laying the chip on its side with the pins of one side on a hard surface pointing away from you and gently pressing down and away on the body of the chip. Be careful not to bend the pins too far. Once inserted, bend the pins at the corners from the bottom slightly in order to hold the chip in place.

Make sure that all of the pins from the chip are completely inserted through the holes in the board before soldering in place from the bottom.

Step 2. Repeat for U1, U2, U4, U5, U6, and U7 (74ACT540)

Step 3. Repeat for Q1 and Q2 (ULN2803 or TBD62083).

Step 4: Locate resistors R1-30 (See table for value). Bend the leads of one resistor approximately 90° near the body of the resistor so that it forms a 'U' shape. Do not force the bend any closer than it will go with light finger pressure or you may damage the component. Insert the resistor into the board at the position marked R1 on the board. The direction does not matter. The leads should line up easily with the holes on the board. Once inserted through the board, bend the leads slightly from the bottom to hold the resistor against the board. Solder from the bottom. Trim the excess leads from the bottom of the board with diagonal cutters leaving about 1/16 inch. Repeat for the remaining resistors.

Note: Locations R31 to R39 and connectors J4 should remain unpopulated.

Step 5: Locate capacitors C1 –C7 (100 nF capacitor). Insert one capacitor at the positions marked C1 on the board. The direction of these components does not matter. Bend the leads slightly from the bottom of the board to hold in position and solder in place. Trim the excess lead length to about 1/16 inch. Repeat for C2-C7.

Step 6: Locate capacitors C8 (10uF capacitor). Bend the leads 90° so that the body of the capacitor will lay flat against the PCB and with the long lead through the pad marked with a '+' and the side of the capacitor body marked '-' towards the bottom of the PC board as shown below. Solder in place and trim the leads to about 1/16 inch.

Note: It is very important that this capacitor is attached in the correct direction. The display may be damaged if it is assembled backwards.



Step 7: Locate connector J1 (1x9 connector 'A'). Note that there are three different 1x9 connectors. It is very important that the correct connector is used for each position. Align the connector so that the missing pin is aligned with the white square printed on the PC board. Solder one pin from the back of the board. Confirm that the connector is fully seated against the board. If not, reheat the pin while pressing on the connector. Be careful not to get burned; the pin will get **very** hot on the top side of the board! Once the position of the connector is good, solder the remaining pins.

Step 8: Repeat for connectors J7 (1x6 connector), J2 (1x9 connector 'B') and J5 (1x9 connector 'C'). Important: Make sure that the correct connector is used in each location with the missing pin aligned with the white square printed on the board.

Step 9: Locate connector J3 (2x13 connector). Insert with the right angle into the board so the pins are facing outwards and solder one pin from the back of the board. Confirm that the connector is fully seated against the board. If not, reheat the pin while pressing on the connector. Be careful not to get burned; the pin will get **very** hot on the top side of the board! Once the position of the connector is good, solder the remaining pins.

Step 10: 14-Segment LED's. The 14-segment LED's are installed in positions DS1-DS32.

Install one 14-segment LED in each position. Important: Ensure that the component is installed with the comma (',') towards the bottom of the board and that all 16 pins are correctly seated in the holes.

It is recommended to lay the board face down and solder one pin in each row of the LED. Inspect to ensure that the LED is seated flush with the PC board. If not, reheat the pin while pressing on the display from the front of the board. Once the LED is correctly seated, solder the remaining pins. Repeat for the remaining 31 LED displays.

## **Final Assembly**

Step 1. Wipe or rinse the bottom side of the board with Isopropyl Alcohol, Denatured Alcohol, Flux Remover or water depending on the type of solder used in order to remove the solder flux residue.

Step 2. When the board is completely dry, peel the clear plastic protective film from the front surface of each LED display.

Step 3. Remove the paper backing covering the adhesive from one of the 16-digit foam bezels. Carefully line the openings with the LEDs on the board and install similar to the picture shown below. Repeat for the remaining foam bezel.

**Note: The adhesive is very aggressive. Be careful when handling the bezel after removing the paper backing to avoid sticking it to something or somewhere you didn't intend!**

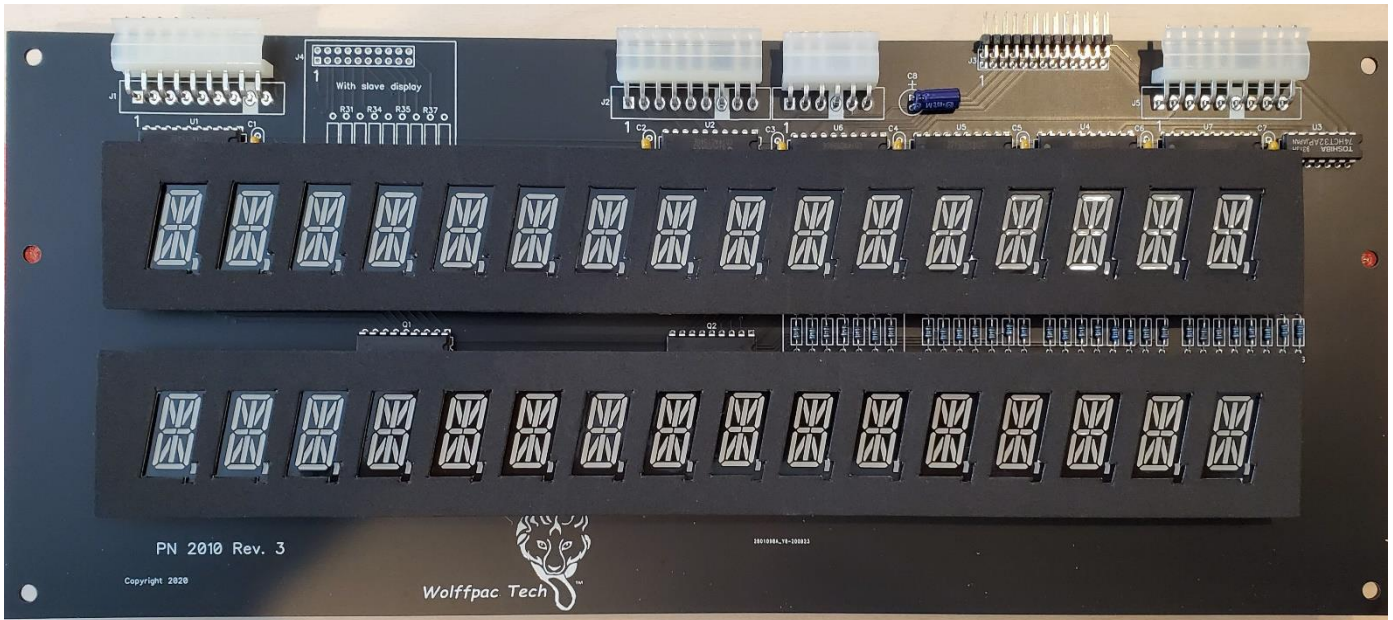

Step 4. With the power off, install the displays in your pinball machine and attach the original cables. The high voltage power supply in your pinball machine is no longer required. If you want, you can remove the fuse on the power supply board to disable it.

Apply power and enjoy!



This is believed to be an accurate list of machines with displays compatible with this replacement. Since we are unable to test this board in every configuration, we take no responsibility for any errors. However, we do welcome feedback as to any errors that are found so that we can update this list.

Williams:

D-12232-1

Bad Cats	D-12232-1 (2x16 alpha)
Black Knight 2000	D-12232-1 (2x16 alpha)
Earthshaker	D-12232-1 (2x16 alpha)
Jokerz!	D-12232-1 (2x16 alpha)
Whirlwind	D-12232-1 (2x16 alpha)
Diner	D-12232-1 (2x16 alpha)
Rollergames	D-12232-1 (2x16 alpha)

